

Manual for installation, operation and maintenance of boiler

THERM 45 KD.A

Hanging gas condensing boiler



Thermona®



**Manual for installation,
service and maintenance
of boiler**

THERM 45 KD.A



CONTENTS

1. General information	4
1.1 Use	4
1.2 Equipment details	4
1.2.1 Equipment description	4
1.2.2 Construction variants	4
1.2.3 General description	4
1.2.4 Simplified hydraulic diagram and functional diagram (is not source material for assembly)	5
1.3 Operational safety	5
1.4 Technical parameters	6
1.5 Set of boiler	7
2. User manual	8
2.1 Control and signalling	8
2.1.1 Boiler control panel	8
2.1.2 LCD display	9
2.1.3 Information menu	10
2.1.4 Error messages	11
2.2 Activation and deactivation of the boiler	11
2.2.1 Commissioning of the boiler	11
2.2.2 Disconnection of the boiler from operation	12
2.3 Regulation	12
2.3.1 Operation of the boiler without the room thermostat or regulator	12
2.3.2 Operation of the boiler with spatial thermostat	12
2.3.3 Operation of the boiler using built-in equithermal regulation	13
2.3.4 Operation of the boiler using built-in equithermal regulation	15
2.3.5 Control of cascade boiler rooms	15
2.3.6 Heating of utility water (DHW)	15
2.3.7 The heating of water in the accumulator storage tank is in the connection with solar panels	16
2.4 Selected protective functions of the boiler	17
2.5 Maintenance and service	18
2.5.1 Additionally filling the heating system	18
2.6 Warranty and warranty terms	18
3. Installation manual	19
3.1 Basic instructions for assembly of the boiler	19
3.2 Complete character of the delivery	19
3.3 Location of the boiler	19
3.4 Suspending the boiler	20
3.5 Connecting the boiler to the hot-water system	21
3.5.1 Dimensions and connection	21
3.5.2 Graphs of the connecting overpressures of heating water (on the output for heating water)	22
3.5.3 Expansion tank	22
3.5.4 Using anti-freeze mixtures	22
3.5.5 Safety valve	23
3.6 Connection of the boiler to the gas distribution	23
3.7 Filling and discharging of the heating system	23
3.7.1 Procedure for filling the heating system	23
3.7.2 Additional filling of water into the heating system	23
3.7.3 Discharging of water from the heating system	23
3.8 Condensate outlet	24
3.9 Design of gas exhaust	24
3.10 Connection of the boiler to the storage tank	25
3.11 Connection of the boiler to the electricity network	25
3.11.1 Connection of the room thermostat	25
3.11.2 Connection of a room regulator with OpenTherm+ communication	26
3.12 Variants for the installation of the boiler	26
4. Additional information for service	27
4.1 Gas fitting SIEMENS VGU 86 – setting	27
4.2 Electrical connection diagram	28
5. Record of warranty and post-warranty repairs and annual controls	29
6. Certificate of quality and completeness of the product	31



1. GENERAL INFORMATION

1.1 Use

The hanging condensing boilers THERM 45 KD.A are modern gas hot water boilers that burn natural gas. The boilers are constructed as consumer appliances using condensed water steam in the combustion process with excellent efficiency, minimum emissions into the air and the minimum consumption of electricity. Operation is economical and does not strain so the environment. The output of the boiler can be fluently regulated within the scope of 29 – 100% and adapted automatically to immediate thermal losses from the object.

THERM 45 KD.A condensing boilers can be used for heating and heating hot water (hereinafter referred to as TV) in indirect-heating reservoirs.

! The boiler is designed for closed heating systems fitted with an expansion vessel or open expansion vessel a minimum height of 8 m above the boiler.

1.2 Equipment details

1.2.1 Equipment description

- this concerns a hung condensing boiler designed for heating of buildings with thermal losses up to 45 kW when used separately and with up to 720kW when connected to a cascade
- option to heat water – heating in indirect heating storage tank
- natural gas operation
- fully automated operation
- low consumption of electricity
- automatic fluent output modulation
- simple boiler control
- high comfort level
- built-in equithermal regulation
- ability to control by the superior indoor thermostat or intelligent indoor control unit
- high level of operational safety
- security elements of the boiler are used to prevent the boiler overheating and gas escapes
- built-in energy saving circulation pump
- safety valve 3 bar
- protective functions (anti-freeze protection, pump protection, etc.)
- electric ignition (saving of fuel)

1.2.2 Construction variants

THERM 45 KD.A

- closed combustion chamber – TURBO variant
- version designed only for heating (water can be heated in an external indirect heating reservoir)
- air for combustion is sucked in from the open air

1.2.3 General description

THERM gas condensing boilers consist of a load-bearing frame, on which all operating elements of the boiler are attached. In the upper part of the boiler is a compact condensing body, which associates the combustion chamber with the burner and the two-chamber stainless exchanger. The coating of the condensing boiler consists of an external thermo-plastic shell, which is reinforced by an internal stainless wall which significantly restricts the passage of heat into the surroundings. **The heat transfer surfaces of the exchangers consist of round tubes which must be protected against blocking by dirt from the heating system.** Due to this reason, the heating system must be fitted with a filter for water returned into the boiler. The collector on the output for the heating water from the body is fitted with a de-aerating valve and a heating probe. The removable front wall of the body is fitted with two electrodes (ignition and ionizing), a tube burner and shaped piping for the supply of gas mixed with air.

A suitable ratio of gas mixed with air is ensured by the mixer in cooperation with a special gas fitting. It consists of a gas pressure regulator, two solenoid blocking valves and ratio regulation of the output volume of gas with elements for mechanical setting. The parallel ratio regulation can only be set by using special devices. The whole system operates so that the volume of added gas is directly proportional to the volume of air through the mixer delivered with the ventilator. Therefore it can be stated that the output on the boiler depends on the volume of the air flow for combustion.

As a result, the revolutions of the ventilator are fluently controlled within a wide range which ensures the high output range of the boiler. The air is supplied into the ventilator is through the shaped piping from the connection system.

The supply of combustion air, including the forced exhaust of burnt gases outside the boiler is, as a rule, ensured by coaxial

piping which runs horizontally through the peripheral wall or vertically through the roof construction into the open air. It is necessary to install the piping to prevent (due to the low temperatures of burnt gases) the possibility of the freezing of the exhaust terminal. Vertical piping must terminate at the roof chimney, horizontal led with a slight slope into the exhaust from the boiler.

The outflow of condensate from the condensation body, exhaust piping for burnt gases and the supply of air are directed by hoses into the odour closure if the condensate flows outside the boiler.

To ensure the flow of water through the boiler, a circulation pump is fitted on the input for the return water. A sufficient heating water flow is monitored by a flow switch. The boiler is also fitted with a safety valve for over-pressure protection of the boiler.

The control panel is completely plastic. On the front side there are control elements (see "User Manual" chapter). Inside is a single-plate HDIMS 20-TH20 automatic system to control and regulate the activity and security of the boiler.

1.2.4 Simplified hydraulic diagram and functional diagram (is not source material for assembly)

THERM 45 KD.A

- 1 - Gas valve Siemens
- 2 - Safety valve
- 3 - Circulation pump
- 4 - Flow switch
- 5 - Condensing body
- 6 - Emergency thermostat
- 7 - Thermal probe for heating
- 8 - Pressure switch

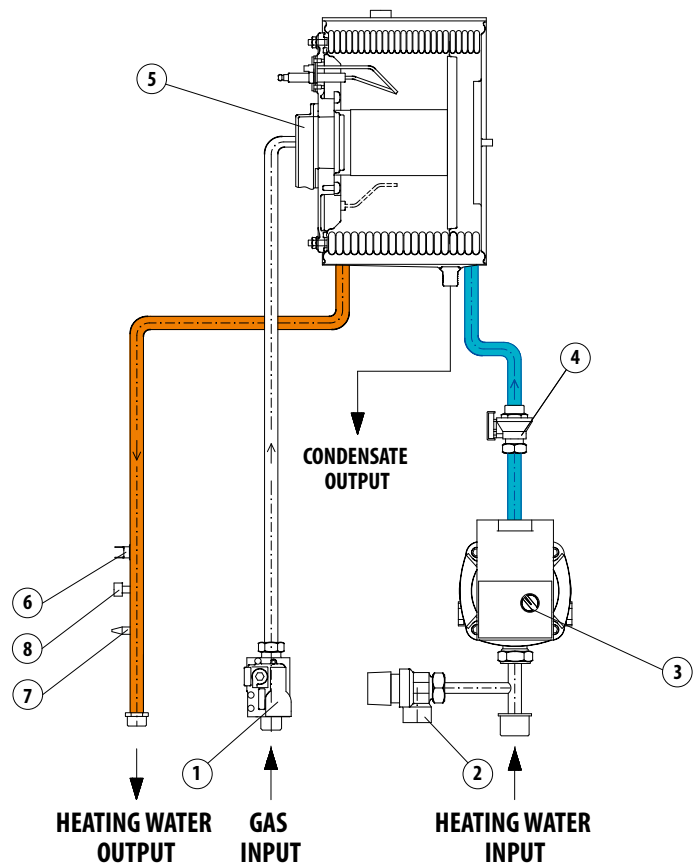

1.3 Operational safety

! THERM boilers are fitted with all safety, emergency and protective elements to ensure completely safe boiler operation. If irrespective of this, e.g. due to unprofessional intervention, irregular inspections and revisions of the boiler, etc., there is a non-standard status then we recommend proceeding as follows:

In the case of gas odour:

- close the gas valve under the boiler
- ensure ventilation of the room (windows, door)
- do not manipulate the electric switch
- liquidate any naked flame
- immediately call service (the boiler must not be used until after the service inspection)

In the case of an odour of combustion burnt gases:

- disconnect the boiler
- ensure ventilation of the room (windows, door)
- call service (the boiler must not be used until after the service inspection)

In the case of a consumer appliance fire:

- close the gas valve under the consumer appliance
- disconnect the consumer appliance from the electricity network
- liquidate the fire with powder extinguishing equipment or a foam extinguisher

1.4 Technical parameters

Technical description	Unit	THERM 45 KD.A	
Fuel	-	natural gas	
Consumer appliance category	-	I_{2H}	
Nominal thermal input power	kW	42.50	
Minimum thermal input power	kW	12.25	
Nominal heat output at	$\Delta t = 80/60 \text{ } ^\circ\text{C}$	41.70	
	$\Delta t = 50/30 \text{ } ^\circ\text{C}$	45.00	
Minimal thermal output by	$\Delta t = 50/30 \text{ } ^\circ\text{C}$	13.00	
Drilling gas curtains	mm	10	
Gas overpressure on the consumer appliance input	mbar	20	
Consumption of gas	$\text{m}^3 \cdot \text{h}^{-1}$	1,28 – 4,52	
Maximum overpressure of heating system	bar	3.0	
Minimum overpressure of heating system	bar	0.8	
Maximum input pressure of cold water	$^\circ\text{C}$	80	
Diameter of coaxial of exhaust for burnt gases	mm	80/125	
Average temperature of burnt gases	$^\circ\text{C}$	50	
Usable over-pressure of the ventilator	Pa	80	
Max. noise according to ČSN 01 16 03	dB	54	
Boiler efficiency	%	98 – 106	
NOx class of boiler	-	5	
Nominal supply voltage / frequency	V / Hz	230 / 50 ~	
Auxiliary electricity at	nominal heat input power	W	141.4
	partial loading	W	94.6
	emergency status	W	4.4
Nominal current of the circuit breaker for consumer appliance	A	2	
Level of coverage of electrical part	-	IP 41 (D)	
Environment according to ČSN 33 20 00 – 3	-	basic AA5 / AB5	
Dimensions of boiler: height / width / depth	mm	800 / 430 / 370	
Weight of boiler	kg	45	

1.5 Set of boiler

THERM 45 KD.A

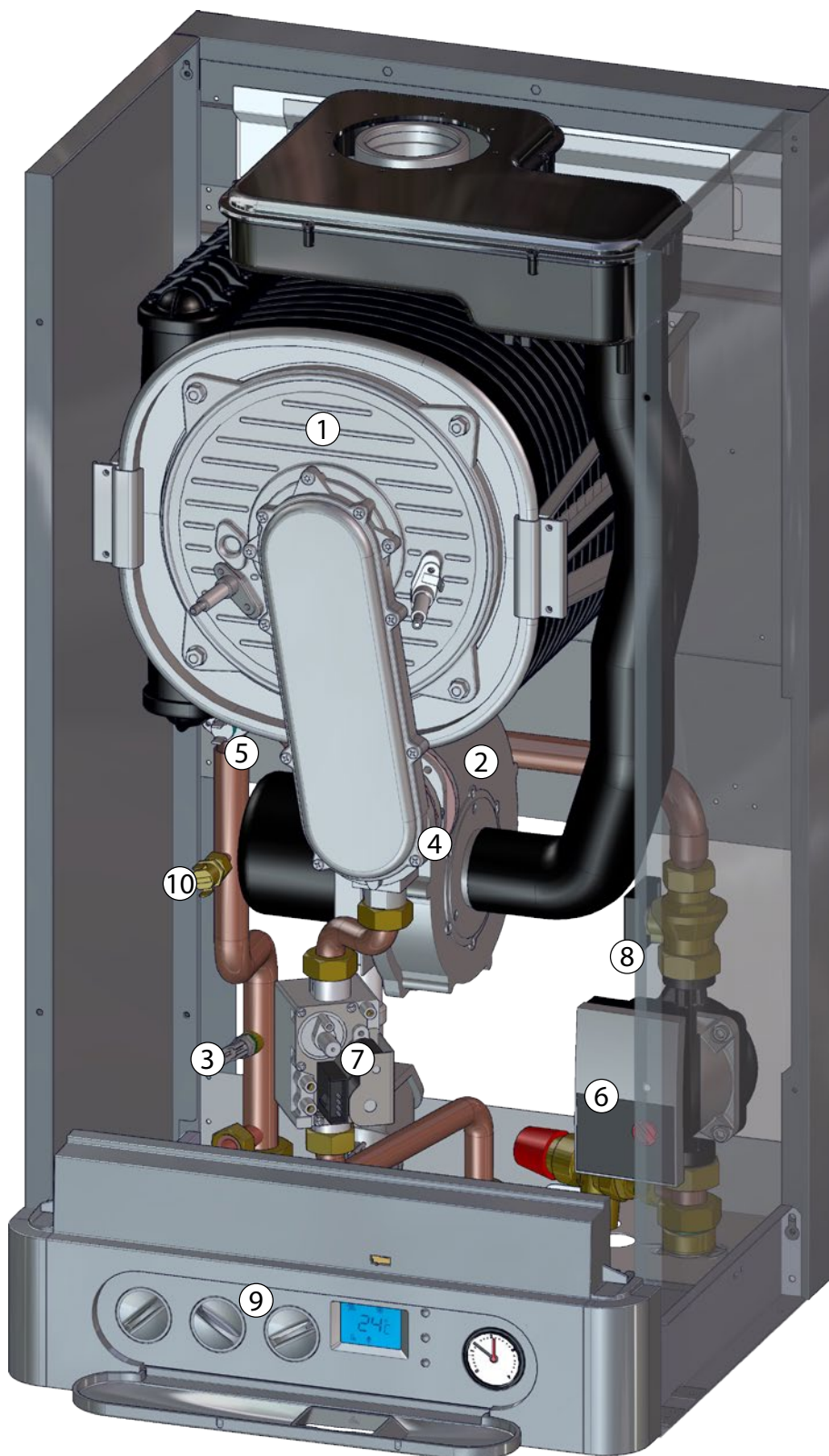

- 1 - Condensing chamber
- 2 - Ventilator
- 3 - Thermal probe for heating
- 4 - Mixer
- 5 - Emergency thermostat
- 6 - Circulation pump
- 7 - Gas valve
- 8 - Flow switch
- 9 - Control panel
- 10 - Pressure switch

2. USER MANUAL

2.1 Control and signalling

2.1.1 Boiler control panel

Control elements of the boiler are hidden under the plastic cover. The cover is opened by lightly gripping the handle in the upper part or by pressure on the lower part of the hole for the display.

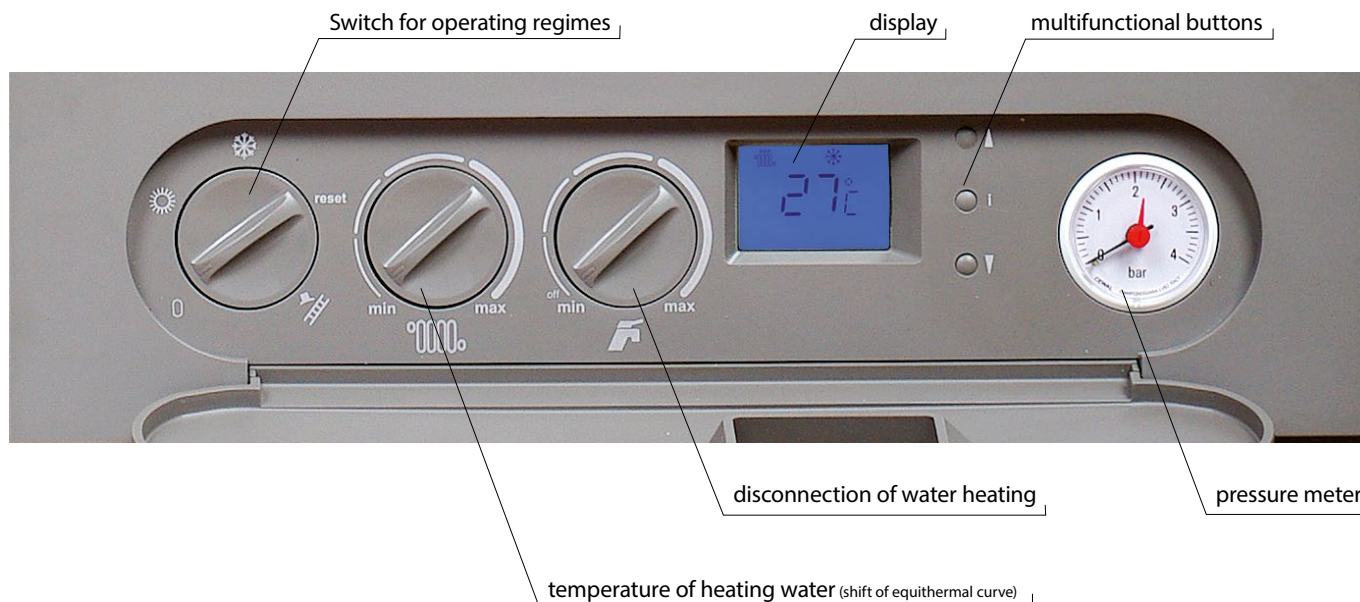

The switch for operating regimes - has the following positions

- 0 Disconnection of the boiler** – the protective functions of the boiler remain in operation (when the boiler is connected to the electricity network and the gas supply is opened). If selecting this mode, the boiler display only indicates the pressure in the heating system, the heating is disconnected, there is heating of DHW and, at the same time, the backlit display is OFF.
- Sun Summer regime** (only heating of DHW is ON, the heating is OFF)
- Snowflake Winter regime** (heating and heating of DHW is ON)
- reset Unblocking the failure status of the boiler**
- Wrench Service mode** (the function “sweeper” – the output of the boiler can be fluently regulated by the wheel – left position = minimum output and temperature, right position = maximum output and temperature). This regime serves only for service activity and measurement (emissions, temperatures of burnt gases, etc.)
- Radiator Setting the heating temperature** – rotary control knob for user setting of the output temperature of water in the heating system within the range 30 – 80 °C. In the case of selected equitherm regulation, the shift in the heating curve is set by the control knob (within the range ± 15 °C from the equithermal curve)

 **Setting the water temperature** – not used, only active when using the machine to heat the solar accumulation reservoir. The water temperature for THERM 45 KD.A boilers connected to the standard reservoir is set directly on the thermostat for the reservoir.

Disconnection of water heating – setting the rotary control knob for user setting of the output temperature of the hot water to the left side position (less than 10° of the route); the heating of water can be permanently disconnected from operation.

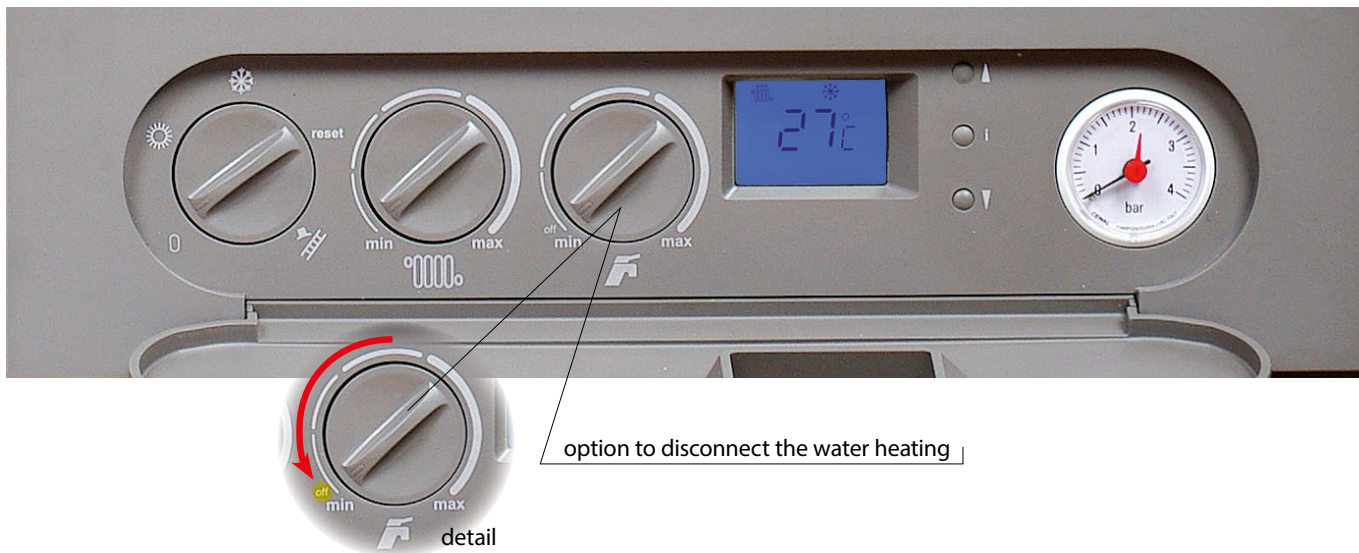

Multi-functional buttons – designated for the diagnostics and setting of the parameters of the boiler exclusively by a service technician or for switching off information data (see below)

Manometer – displays the measured water pressure in the heating system





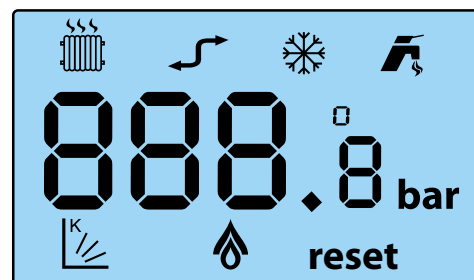

2.1.2 LCD display

Indication of set temperature



After turning the control knob for setting the temperature of the heating system or DHW (boilers with flow heating of DHW) the respective symbol of the regime will start to flash along with the numeric display of the temperature on the LCD display. In this case, the value of the last temperature set is indicated. After the termination of the setting, the indication of the set temperature remains for about 5 seconds. The following permanent display of the numeric value and the symbol, the real temperature of the respective regime is indicated again.









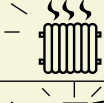

Description of symbols shown on the display

SYMBOL	NAME	MEANING
88.8	Display field	Display of temperatures, failure statuses and service values
	Valve	Permanent lighting – the boiler is in the water heating mode Flashes – displays the hot water temperature or the requested water temperature
	Radiator	Permanent lighting – the boiler is in the heating mode Flashes – displays the hot water temperature or the requested water temperature
	Flame	Permanent light - the burner burns Flashes - the burner burns during the service mode
	Curve ("K" factor)	Permanent lighting – the equithermal heating regime is selected Flashes – displays the "K" factor, not usual with °C outside temperature
	Frost flake	The boiler is in "WINTER" mode
	Communication	Steady light - Opentherm+ communication is active Flashes – communication with the interface of the cascade is active

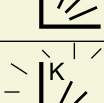
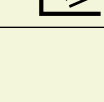
2.1.3 Information menu

Buttons  and  are used for entrance and bi-directional browsing in the information menu in the following sequence order:

	PARAMETER	SHOWS ON THE DISPLAY
	The required heating temperature	 35 °C
	The temperature of heating	 35 °C
	Requested temperature DHW (2)	 35 °C
	Temperature DHW (2)	 35 °C
	Outside temperature (1)	 16 °C
	Equithermal curve (factor „K“)	 1.6
	Temperature of water returned from the system	35 °C
	Ventilator speed	four-digit value of revolutions per minute
Return to normal display		

If button  or  is not pressed for 10 seconds, or if pressing buttons  and  at the same time, the information menu is terminated.

- (1) - an outdoor temperature display is only available in the case of the correction of the respective sensor and the selection of equithermal regulation
- (2) - when selecting heating of water in the external reservoir, display "- -", (with additional heating of the solar accumulator, the numeric value is displayed - see below)

2.1.4 Error messages

Any error or other anomaly is indicated by flashing, a backlit LCD display, display of the error code and key symbol. On the first position of the display is symbol "E"; on the other positions is an error code with the meaning according to the table.

Error code displayed on LCD and the meaning:

ERROR CODE	MEANING
E01 *	Blocking of the activity when the burner is not ignited
E02	Insufficient flow of heating water
E04	Defect in thermal heating probe (interruption of short-circuit)
E05	Defects in the water temperature probe (when connecting to the cascade, defect in system temperature probe)
E06 *	Blocking of activity after overheating of the boiler (emergency thermostat)
E07	Defect to the outside temperature sensor
E08	Failure of ventilator (feedback signal for revolutions)
E09	Failure of ventilator (revolutions outside the regulation range)
E10	Failure of ventilator (rotate at STOP)
E12	Failure of insufficient pressure of heating water after 4 pump cycles
E16 *	High temperature of burnt gases in the condensing body (temperature is too high in the condensing body)
E22	Low pressure of heating water

* The boiler is blocked. To reactivate the boiler, manually reset by switching the regime.

The error code is saved into the memory of the processor where it is also saved in the case of a supply failure. The service technician can check the memory and ascertain the history of failure statuses.

2.2 Activation and deactivation of the boiler

2.2.1 Commissioning of the boiler

! The boiler must only be commissioned by a service employee authorised by the producer! The list of service technicians is attached to the product.

Action to be taken before and during the activation of the boiler.

Before the first activation of the boiler it is necessary to take the following measures:

- check that the heating system is filled with water and the boiler is correctly de-aerated
- ensure that all valves under the boiler and in the heating system are open
- open the gas valve and, using the gas escape detector or foam-making solution, test the tightness of the gas distribution in the boiler

! If the boiler exchange is not de-aerated, irreversible damage to the boiler may occur!

The procedure for the first ignition of the boiler is as follows:

- set the rotary button of the input temperature of the heating water of the boiler to the maximum
- insert the network supply into the socket and switch on the boiler with the switch for operating regimes
- by briefly turning of the operating regime switch to the right, the boiler is automatically activated (when the gas supply is de-aerated)
- inspect the correct activity of all thermostats and control elements
- inspect all functions of the boiler
- adjust the burning of the machine or modify the setting according to demands of the area to be heated
- train the user



The setting of output range of the boiler and other parameters must be in accordance with the technical data. Any overloading and incorrect use of the boiler may cause the devaluation of its components. The warranty cannot be applied for such damaged components!

The boiler must not be operated with the emergency or flue thermostat or manostat excluded from operation or replaced by other equipment than that stated by the producer! Otherwise, an accident or other hazardous statuses may occur!

A service technician authorised by the producer must familiarize the user during activation with the operation of the boiler, the individual parts, the safety elements and the manner of control, complete the Warranty Certificate and give this user manual to the user.

The user is obliged to ensure of the correct use of the boiler in accordance with this manual which is a conditions of acceptance of the warranty. In addition, it is strictly forbidden to intervene in any manner into the secured parts in the boiler!

2.2.2 Disconnection of the boiler from operation

It is possible to disconnect the boiler for a shorter period by the operating regime switch or by the switch on the room thermostat.

For longer disconnection of the boiler outside the heating season (e.g. during summer and holidays) it is recommended to close the gas valve. However, leave the boiler connected to the electricity network. Only in this case will the protective functions of the boiler be active.

Any full disconnection of the boiler (closing of gas supply, disconnection from electricity network) must be done with respect to the ambient temperature of the environment in the respective season! There is a risk of the heating system or DHW circuit freezing due to damage to the boiler or other elements of the heating system.

2.3 Regulation

The boiler is fitted with internal regulating elements at a high level for such basic equipment. The standard is integrated equithermal regulation. The heating in the heating system can be controlled in several ways: regulation of the room temperature in a selected reference room; equithermal regulation of heating water, regulation according to the boiler temperature.

2.3.1 Operation of the boiler without the room thermostat or regulator

In this regime the boiler maintains the selected temperature of the heating water. The room thermostat or the regulator is not connected; the terminals for connection must be mutually interconnected (set in production).

In this regime, set the temperature of the heating water directly on the control panel of the boiler with the middle button.



The operation of the independent boiler (without selection of equithermal regulation) is recommended to be controlled using at least a simple room thermostat. The room temperature is time stable and keeps the boiler in the operating regimes. It is recommended to use the built-in equitherm regulation either independently or completed by the spatial regulation, as mentioned below.

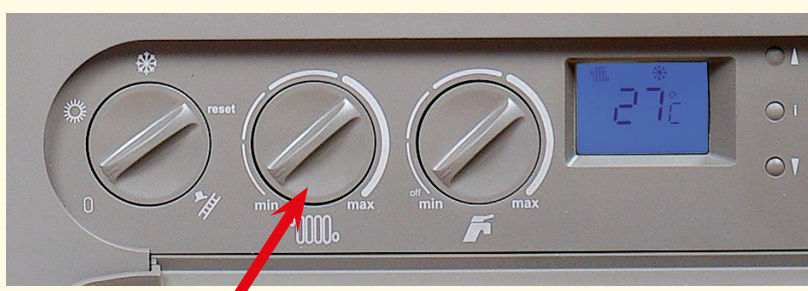

2.3.2 Operation of the boiler with spatial thermostat

In this manner of regulation, the boiler maintains the selected temperature of heating water. Indoor thermostat is connected with the jumper of the terminal X9 on the boiler control automatics. The operation of the boiler is consequently controlled according to the inside temperature in a room where the room thermostat is located (the reference room). It is not recommended to mount thermostatic valves on radiators in the reference room!



For control according to room temperature, Thermona delivers and recommends the whole series of room thermostats: e.g. PT 22, Honeywell CMR 707, CMT 727 (wireless version) etc.

The mentioned ad-in regulators are not (with the exception of special offers) included in the delivery of the boiler!

Description of the activity of the boiler in the mentioned regime:

The working phase of the boiler starts by switching on the room thermostat (the thermostat evaluated low temperature compared with requested) at the moment when the regime control knob is in the winter regime position. The three-way valve relay is disconnected (for boilers with water storage heating); the of circulating pump is activated, as well as the ignition system and ventilator. Ignition of the boiler is for the adjusted starting output. It remains for 2 seconds after activation of the boiler. The output is then decreased to the minimum with a slow linear start (about 50 s) to the modulation point stated by service for setting the maximum heating output. The regulation of output of the boiler in this phase is by PID (proportional/integral/derivative) with keeping the temperature set by the wheel on the control panel (within the range 30 – 80 °C). During the whole time of heating, the regulation limit of the output temperature is checked. When heating the system with lower input power than the minimum output of the machine, there is an increase of the output temperature of heating water by 3 °C above the adjusted temperature (for 30 seconds from ignition, this value is increased to 10 °C). In this phase the boiler interrupts the burning while still running the circulating pump and activates the restriction of reignition (service setting within the range 0 – 10 min.). In this manner the boiler becomes a highly adaptable source of heat due to the high variability of the consequently regulated heating sets (e.g. use of zone regulation, thermostatic valves, etc.).

After disconnection of the spatial thermostat or after switching the selection unit into the "WINTER" mode, the burning of the burners is stopped and the pump is ON for the set time (service setting within the range 0 – 10 min.). This function is used for taking the heat from the condensing body and for improving the allocation of temperatures of bodies when using thermostats with PI linkage with short working cycles.

! In the case of the installation of the room thermostat eventually, and controller in the reference room, a minimum of one radiator must be left without a thermostat head. To increase thermal comfort, we recommend not to mount thermostatic heads on radiators in the reference room at all.

2.3.3 Operation of the boiler using built-in equithermal regulation

This regime is accessible in the boiler in the standard variant but is not activated. The activation and the primary setting of the regulation is performed at the request of the client by an authorized service technician.

During equithermal regulation the boiler changes the temperature of the heating water automatically according to the changes in the outside temperature.

This manner of regulation can only be used with the connected outside temperature sensor. The outside sensor is located on the coldest wall of the object (north or north-west) approximately 3 m above the ground. The sensor must not be influenced by any other thermal influence such as open windows, sunlight, ventilation shafts, etc.

Description of the activity of the boiler in this regime:

The working phases of the boiler are identical with the previous regime with the difference that the temperature for the heating system is automatically set according to the outside temperature (ascertained by the sensor). The calculation of the requested temperature of the heating system is the function of the ambient temperature and the function of the "K" factor (declination of equithermal curve), which is set by the service technician with respect to the locality and nature of the heating system. Using the heating water knob on the control panel, the user sets the requested thermal comfort (correction of the shift of equithermal curve within the range ± 15 °C of the heating water). The equithermal curve is modified for standard heating systems with radiators.

In the case of failure of the ambient temperature sensor, this status is signalled by E07 failure and the boiler continues in operation with the temperature of the heating system according to the setting in the previous regime (without equithermal regulation).

Adjustment procedure:

When setting the equithermal regulation, it is necessary to distinguish the declination and the shift of the equithermal curve. By setting of **the declination** the following rule applies : in the case of poor thermal-insulating properties of the object, change the parameters of the declination of the curve in the direction of the higher values (the curve is moved upward); in the case of good thermal insulation, the parameter can be decreased (the curve is moved downward).

The declination of the curve is set by the authorized technician in the service menu of the automatic control system of the boiler!





During the activated equithermal regulation the meaning of the function of the middle button on the control panel of the boiler is changed. In this case, the mentioned knob is used to set the shift of the heating curve (within the range $\pm 15^\circ\text{C}$ from the equithermal curve set by the service technician).

It results from the mentioned facts that using the knob to set the temperature of the heating on the control panel, in this regime, the requested temperature of the heating space is indirectly set. At the beginning (in the production) the equithermal curve is set for „K“ = 1,6. The initial user setting of the rotary control knob is in the middle of the setting route (the indicator is up which corresponds to the shift of the curve 0°C). After inspection of the temperature of the heated space (after approximately 24 hours), it is possible to perform additional setting according to all requirements for thermal comfort. Due to the influence of the equithermal regulation the change of ambient temperatures will be compensated and the level of temperature of the heated space will be automatically kept at a constant level.

Using this regime of regulation, a further decrease of operating costs can be achieved while improving thermal comfort (continuous heating of heating bodies). Finally, this option can be appreciated as pre-regulation of the primary heating circuit when using zone regulation (by mixing valves), etc.

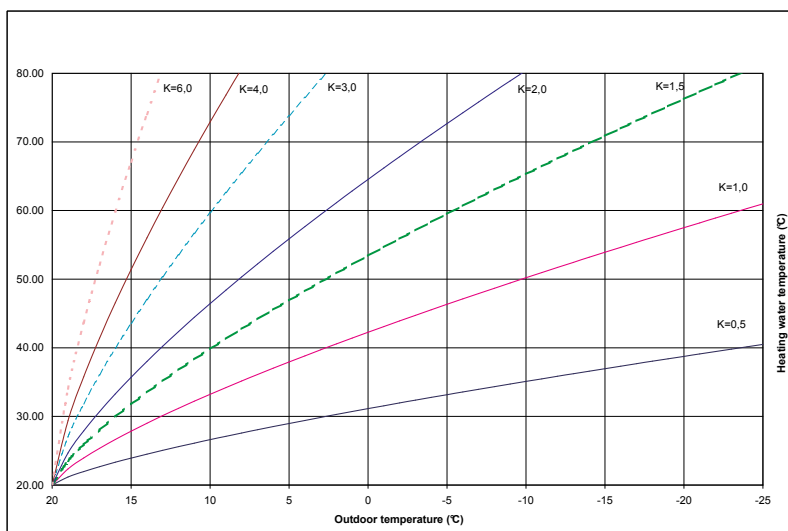

Graph of the course of equithermal curves (zero shift)

The calculated temperature of the heating water is restricted to max. 80°C . If the calculated temperature varies within the range $20 \div 35^\circ\text{C}$ the requested temperature is restricted to the minimum temperature of the boiler, i.e. 30°C and the function of periodical running of the boiler is activated within the fixed interval of 15 minutes and the variable time of running for 35°C according to the formula:

$$T_{\text{on}} (\text{min}) = 15 - T_{\text{off}}; \text{ which } T_{\text{off}} (\text{min}) = 35 - \text{calculated equitherm temperature}$$

If the calculated equitherm temperature $\leq 20^\circ\text{C}$, the boiler remains disconnected.

Note:

T_{on} = interval of activation of the boiler

T_{off} = remaining interval for the disconnection of the boiler into fixed 15 minutes

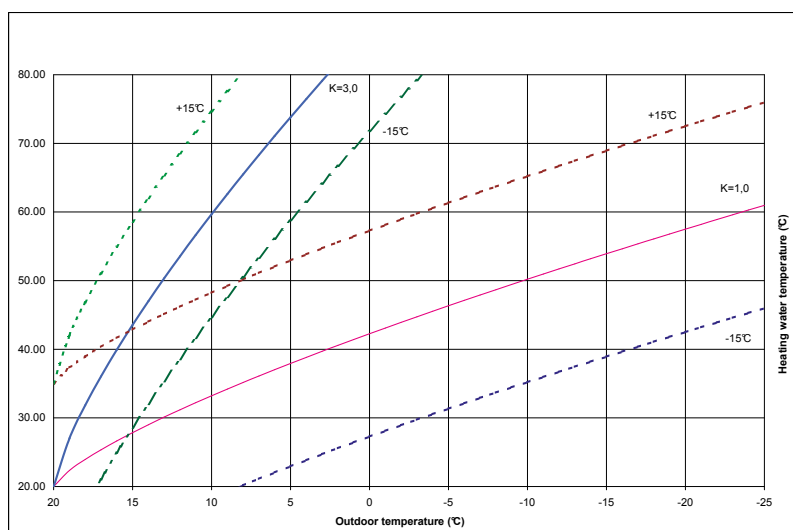

Example of the course of selected curves during correction of the shift (middle button):

2.3.4 Operation of the boiler using built-in equithermal regulation

After ensuring “full value” equithermal regulation (including setting the time programmes, etc.) it is recommended to use intelligent programmable regulator CR 04 , PT 59 or PT 59X, which regularly communicates with the microprocessor of the automatic boiler system. There is the transfer of information not only about the required temperature of the heating system depending on the spatial and outside temperature, but also the display of operating information about the boiler (work regime, performance, temperatures, possible failures, etc.). This system is characterized by many adjustable and displayed parameters for optimal control of the heating equipment with modulation of the boiler output.



The mentioned ad-in regulators are not (with the exception of short-term special offers) included in the delivery of the boiler!

2.3.5 Control of cascade boiler rooms

THERM 45 KD.A hanging boilers can be connected to the cascade. It is already well known and time-tested principle of boilers, both from the hydraulic and the control point of view. The boiler cascade can be conveniently controlled by our unique communication system that ensures the continuous communication between the individual boilers. For this purpose, Thermona provides the IU 05 and IU 04.10 interfaces. The IU 04.10 interface ensures the transfer of information and calculations for the power requirements of the boiler (number of working boilers and the modulation of the power). The IU 05 interface (sw 2.04 or higher) for the control boiler of the cascade has similar properties as the IU 04.10 interface (communication between boilers) and also ensures communication with the programmable regulator (PT 59, CR 04). This system has more programmable options for the display of the operating status of the boiler room (operating modes, power, temperature, possible failure of individual boilers, communication disorders, the possibility of deactivating the heating HSW tank with regulators PT 59 and CR 04).



For more information about the principle, design, type of cascade boiler rooms control etc. are available, for example on the website www.thermona.cz.

2.3.6 Heating of utility water (DHW)

THERM 45 KD.A boilers are adapted in a standard manner for heating water in an external indirect-heating reservoir. To ensure heating of the HSW is necessary to install the three-way valve on the boiler as shown on the figure below.

Reservoir heating of water – DESCRIPTION OF ACTIVITY

If the thermostat of the hot water storage tank is ON, the working phase of heating of the storage tank starts. The three-way valve relay is switched on and if the boiler was running in the phase for heating the heating system, the burner and pumps are stopped.

After re-setting of three-way valve (within the time interval of 8 seconds), the pump is activated. After the sequence for the inspection of security elements, the ignition of the burner is enabled.

From detecting the presence of the flame, the starting output of the boiler is kept for 2 seconds and then there is the phase of fluent modulation of the output with PID regulation with the stated value of the temperature of heating of 80 °C. During the whole time of heating, the limits of the regulation of the output temperature are checked. In the case of any increase above 86 °C the burning is stopped and circulating pump remains active. The reignition is in the case of a decrease of the temperature under 80 °C. The working phase of the water heating terminates with the disconnection of the thermostat of the hot water storage tank.

This is followed by stopping the burning and then there is the additional cooling of the exchanger with the time function for the running of the circulating pump (10 seconds). After termination and stopping of the pump, there is switching of the three-way valve and resetting is activated. The time for resetting the three-way valve is treated by the time function for blocking the activity of the boiler for 8 seconds. Only then, can the requested heating of the heating system be run.

In the case of parallel requests, the water heating regime takes priority over the heating of the heating system.

The informative connection diagram of the indirect heating storage tank to the gas boiler

- 1 – Gas boiler
- 2 – Indirect heating storage tank
- 3 – De-aerating valve
- 4 – Heating system
- 5 – Supply of cold water
- 6 – Connection of the thermostat for the storage tank
- 7 – Output DHW
- 8 – Discharging vent

- U – Closure on the cold water inlet
- Z – Testing valve
- K – Return valve
- P – Safety valve
- M – Pressure meter
- E – Expansion tank (recommended)

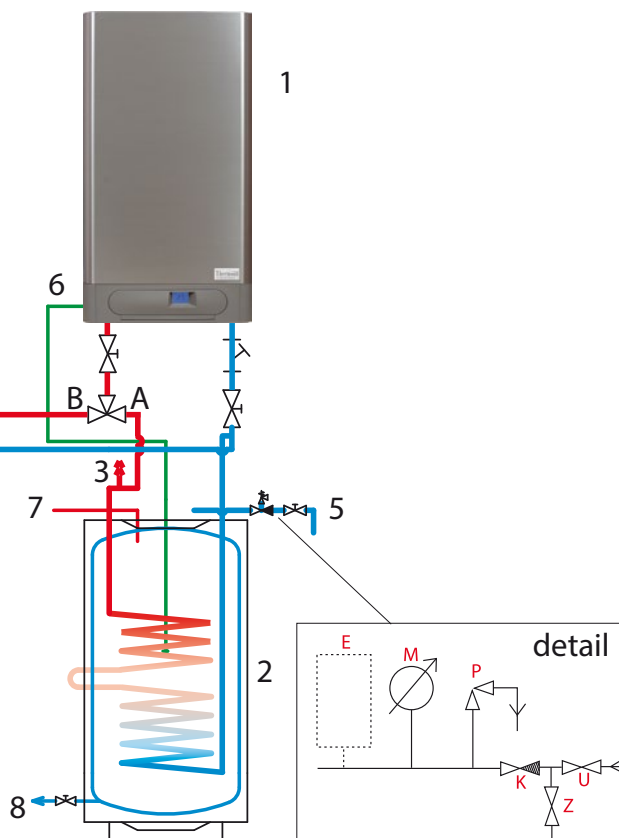

2.3.7 The heating of water in the accumulator storage tank is in the connection with solar panels

Gas condensing boilers THERM 45 KD.A can be used for heating the solar system with the accumulation storage tank. Our geographical conditions do not enable to operate a solar system without the additional (backup) heat source which in this case is the gas boiler. The boiler independently takes care of heating and when requested, it is able to additionally heat the solar accumulator.

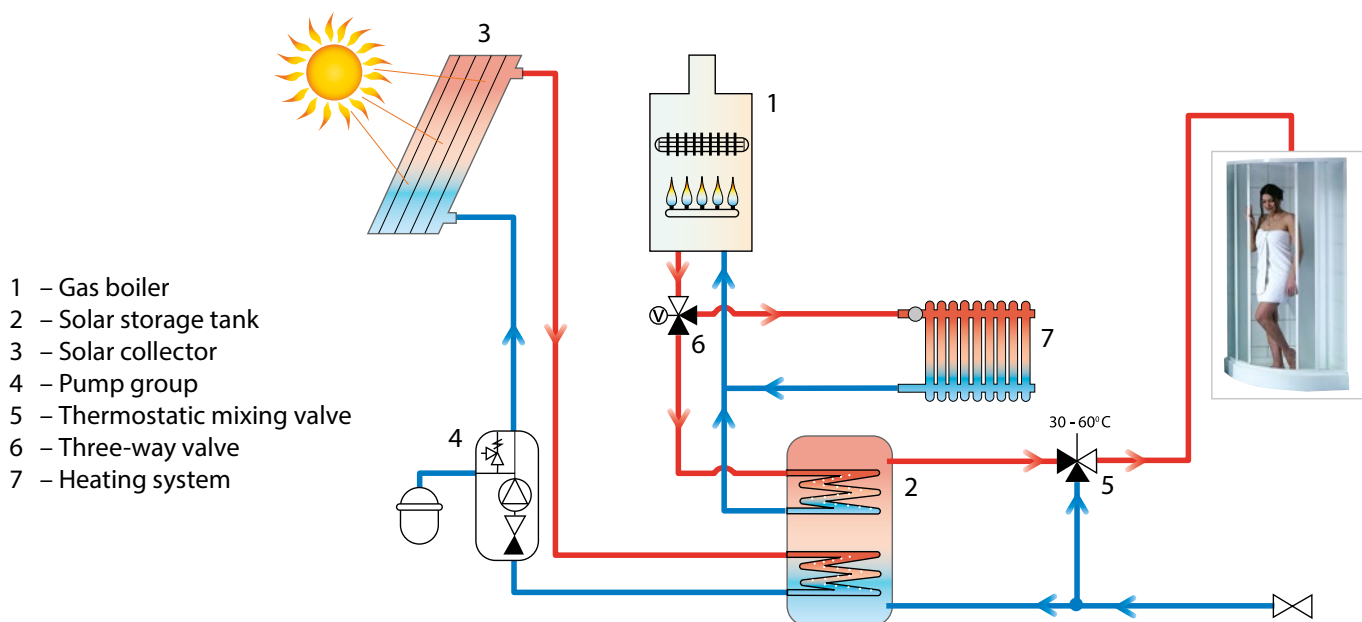

- 1 – Gas boiler
- 2 – Solar storage tank
- 3 – Solar collector
- 4 – Pump group
- 5 – Thermostatic mixing valve
- 6 – Three-way valve
- 7 – Heating system

Description of the activity of the boiler in this regime:

This working mode has the same behaviour as "Storage water heating" described in one of previous chapters with the difference that the temperature in the accumulator water storage tank is read by a thermal probe instead of the thermostat for the storage tank. The setting of the requested water temperature is enabled either from the communication line or by the rotary control button for hot water on the boiler panel. The hot water temperature probe must be connected and functional, otherwise the heating of the water is stopped. With the connection of the contact on the terminals of the storage tank (not used in this case) the forced temperature of heating is 60°C (independently of setting the temperature of water DHW). This function protects against any origination of harmful bacteria such as Legionella.

2.4 Selected protective functions of the boiler

Anti-blocking functions

After 24 hours of inactivity, the pump runs for 30 seconds to prevent any blocking. After 24 hours of inactivity, the three-way valve relay is activated for 10 seconds (if the boiler is fitted with it) due to the same reason. In the case of a request for heating (heating or hot water) during the execution of this function, the anti-blocking function is automatically terminated and the request runs. The anti-blocking function is also active when blocking the activity of the boiler in the position of the driver in the mode "OFF" (if the boiler is still connected to the electricity network).

Anti-freeze protection

The boiler is fitted with an anti-freeze protection system which protects the boiler (not the heating system, storage tank and hot water distribution lines) against freezing. Anti-freeze protection is activated in the case of a decrease of the temperature in the boiler under 6 °C. The pump is activated, the boiler is ignited and heats the heating circuit with a minimum output of 30 °C. The burning is stopped at this temperature and the pump continues running during the function for running the pump. If the boiler is in the status for blocking burning (failure), only the pump is activated. The anti-freeze function is also active with the selector in the position of the control knob in the position "OFF" or in "SUMMER REGIME".

Checking the flow (checking the operation of the pump)

Before each ignition of the boiler there is a check of the flow switch, which evaluates the correct function of the boiler pump. Rechecking the flow switch is activated if within 15 seconds of running the pump, the flow sensor is not activated. The pump is stopped and after 15 seconds there is the next attempt to activate the boiler. This phenomenon is repeated 4x with consequent signalling of the failure E12. It is necessary to de-block the failure by the regime switch. If the time of inactivity of the pump before rerunning the boiler exceeds 30 minutes, the first interval for running the pump is prolonged to 180 seconds. For restoration of the activity of the boiler it is necessary to disconnect and connect using the rotary control knob for selection of regimes or by disconnecting and connecting the network supply.

Anti-Cyclic

The function that prevents the cycling of the boiler in the heating regime when in the case of operating disconnection of the boiler, re-ignition of the boiler is not permitted before expiration of the adjusted, anti-cycling time (5 minutes are set in the production). This function is mostly used in such heating systems where the maximum thermal loss of the stated object corresponds to the lowest limit of the power range of the boiler.

 **The anti-cycling time within the range 0 - 10 minutes can be only be changed by an authorized service technician!**

Run-out of the pump

The run out of the pump is set in production for 5 minutes. After the extinction of the burner caused by the disconnection of the room thermostat, the pump continues to operate during the adjusted run out of the pump. In the case that in the winter regime the boiler is operated without the room thermostat, the pump continues to be ON.

 **The change of the run out of the pump during the operation with the room thermostat within the range 0 - 10 minutes may only be performed by an authorized service technician.**

Run-out of the ventilator

After termination of burning, the ventilator is in operation for 30 seconds while keeping the revolutions corresponding to the starting output (taking the remaining of burnt gases from the combustion chamber).

 **Notification: All the above-mentioned security and registered functions are in activity only if the boiler is connected to the electricity!**

 **With respect to the request for increased checking of the microprocessor once every 24 hours of operation, the forced reset of electronic system is performed with the consequent initialization (it is reflected by short-term interruption of the boiler and deactivation of data on the display similarly as during the activation of the network inlet of the boiler into the socket).**

2.5 Maintenance and service

Regular maintenance is very important for reliable operation, to achieve a long service life, and efficient combustion. We consistently recommend the user to contact a service organisation in the place of residence and to ensure regular inspections of the boiler after one year of operation (see chapter: Warranty and Warranty Terms). The service technician will for example, inspect the control and security elements of the boiler, inspect the tightness of the gas and water distribution or the cleaning of the burner and the exchanger of burnt dust particles, etc.

For error-free operation of the heating system, it is also necessary to regularly inspect the initial water pressure in a cold condition. In the case of a decrease of pressure below 0.8 bar, it is necessary to additionally fill the heating system.

2.5.1 Additionally filling the heating system

The water is refilled in the heating system (pressing-up of the system) is necessary to perform using the filling valve, which is part of the heating system. Water for filling must fulfil certain parameters, see chapter 3.8.

During additional filling it is necessary to take the following conditions into consideration:

- 
- a) the pressure of utility water supplied into the boiler must be higher than the water pressure in the heating system (otherwise the heating water can flow back to the water mains!)
 - b) the additional filling of water is necessary to be done exclusively under a cold status (the temperature of the heating water in the boiler is a maximum of up to 35 °C)

Procedure for additionally filling the heating system with water:

1. Disconnect the boiler from electrical voltage
2. Slowly open the valve for additional filling and monitor manometer on the control panel of the boiler.
3. Set the system pressure to the necessary value (according to the heating system, recommended 1.0 – 1.5 bar)
4. Close the valve for additional filling
5. Connect the boiler to the electricity network and connect the boiler again

2.6 Warranty and warranty terms

The producer is not liable for any mechanical damage to individual components by rough handling, for damage caused by unprofessional intervention into the electronic system during the adjustment and connection of the add-in regulation, for damages caused by the use of other parts and components than the original components used by the producer.

The warranty is also not applicable to defects caused by non compliance with the binding notifications and terms stated in individual parts of this manual.

The warranty is not applicable to non-standardized relations in distribution networks (variation of electrical voltage – in particular voltage peaks, pressure and cleanliness of gas, etc.), defects to equipment outside the boiler that influence activity, improper collection of burnt gases, dirt in the combustion air, damage from outside influences, mechanical damage, storage, transport and defects originated by natural disasters.

In such cases the service organisation may require that the client pays for the repair.

THERMONA Ltd provides a warranty according to the stated in the Warranty Certificate delivered with the product.

Terms for application of the warranty:

1. Regular, 1x per year, inspection of the gas boiler. Inspections must only be performed by an authorized organisation, i.e. contractual service. The list of service centres is attached to each boiler. The actual list of service centres is available from www.thermona.cz
2. Documentation for all records of warranty repairs and annual inspections of boilers is in the appendix to this manual.
3. Submitting completed and confirmed warranty certificate and protocol on commissioning into the operation of THERM products

3. INSTALLATION MANUAL

3.1 Basic instructions for assembly of the boiler

Hanging condensing boilers THERM 45 KD.A series are designed for operation in standard hot-water heating systems.

Assembly must only be performed by a qualified professional company and it is necessary to pay attention to all advice and notifications contained in this manual. Assembly must be in accordance with valid standards and regulations – see ČSN EN 1775, ČSN 38 6462, ČSN 33 2000 – 7 – 701 ed.2, ČSN 06 1008, ČSN 73 4201, TPG 704 01, TPG 800 02, TPG 908 02, Regulation No. 48/1982 Coll.

Before installing the boiler the assembly company is obliged to check:

- the type of the boiler corresponds to the ordered boiler
- the selection of the boiler is correct for the stated use (type of gas, heating system, collection of smoke, air suction)
- the delivery is complete

3.2 Complete character of the delivery

THERM hanging boilers are delivered fully assembled. All parts of the boiler are checked and set by the producer before assembly. Each boiler is tested for leakage of the water circuit, leakage of the gas circuit and the regulating and protection parts are set and tested.

The standard delivery of the boiler includes:

1. Boiler
2. Manual for installation, service and maintenance of boiler
3. Service network
4. Warranty certificate (3 copies)
5. Protocol on the commissioning of THERM products into operation
6. Application for registration into the prolonged warranty programme
7. Confirmation of completing 1. and 2. service inspection
8. Hanging bar, including fixation elements

Accessories:

Necessary accessories (collection of gases, regulation, outside sensor, etc.) can be ordered on request. Detailed information can be found in the catalogue of products and accessories or at www.thermona.cz.

To collect smoke in the „C“ variant, it is necessary to exclusively use equipment to collect gases delivered by the producer of the boiler. Only by doing this will the boiler report the stated parameters for burning, output, efficiency, etc.

In the case of any doubt or inquiries, contact the producer or supplier before assembly.

3.3 Location of the boiler

The condensing boilers THERM can be installed in the basic AA5/AB5 environment according to ČSN 33 2000-3 and ČSN 33-2000-5-51 ed. 3 (range of temperature +5 to 40°C, moisture depending on the temperature up to a maximum of 85 %, without harmful chemical influences). The combustion air must not contain halogen-hydrocarbons and vapours from aggressive substances, and must not have high moisture and dust levels.

Boilers can be installed in residential and non-residential premises (the noise fulfils Ministry of Health Regulation No.13/1977 Coll.).

The hanging condensing boilers THERM **must not be** installed in premises with bath-tubs, bathrooms, washing areas and special zones 0, 1 and 2 according to ČSN 33 2000-7-701 ed. 2: 2007 and in washing area according to ČSN 33 2130 ed.2: 2009. The coverage of electrical parts is IP 41 (D) and fulfils the conditions for resistance against vertically dropping water – possible location also in premises with wash-tubs or shower in zone 3 again according to ČSN 33 2000-7-701 ed.2: 2007. If the boiler is installed in the respective zones, additional protection must be implemented – additional protective connection

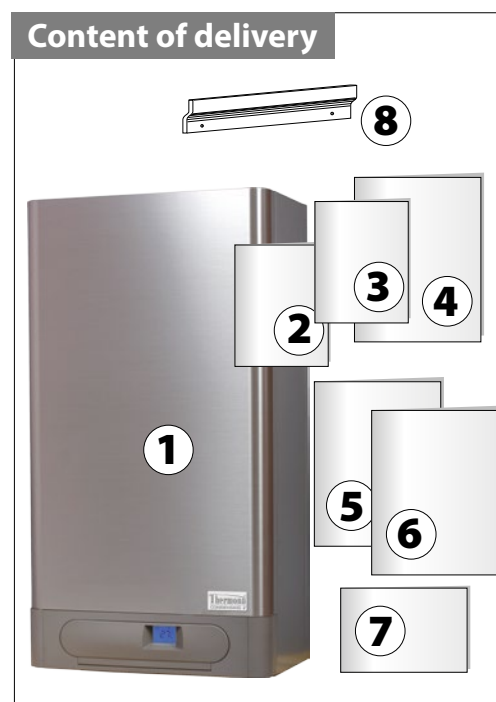

of all conductive parts according to Article 701.415.2 ČSN 33 2000-7-701 ed.2: 2007 and Article 415.2 ČSN 33 2000-4-41 ed.2: 2007. The place of installation must be selected to be able to have access in the case of operation and service inspection. The recommended distances are shown in the following diagrams.

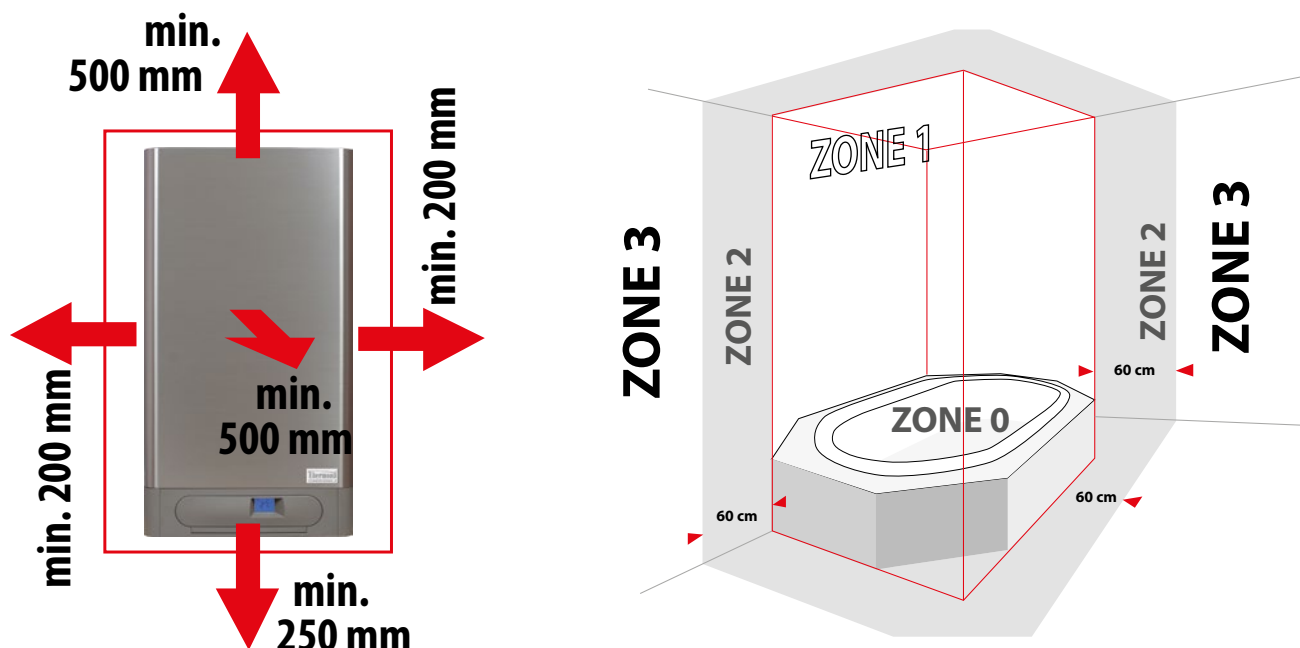

Notice:

Items pursuant to ČSN 06 1008 must not be located near the contour of the boiler (classified according to ČSN EN 13501-1+A1:2010) to the smaller distance as: **100 mm** from materials B – easily flammable, C1 – heavy flammable or C2 – medium flammable **200 mm** from materials C3 – light flammable (e.g. wood-fibre boards, cellulose substances, polyurethane, polystyrene, polyethylene, PVC, etc.)

The safe distance between flammable items and the boiler is 50 mm; from the chimney flue and the control hole 200 mm. Flammable items must not be located at lower distances. The wall on which the boiler will be suspended must be constructed from fire-proof material.

Before starting work that may cause a change of the environment in the area of the installed boiler (e.g. work with painting substances, glues, etc.), it is necessary to disconnect the boiler using the regime switch (position with the pointer on "0") and to disconnect it from the electricity network (remove the network fork from the socket).

3.4 Suspending the boiler

THERM hanging boilers in the 45 KD.A serie are suspended on the wall by the suspension bar delivered with the boiler according to the diagram.

Procedure for suspending the boiler:

1. Consistently measure the position of the suspension of the boiler (according to the diagram with the dimensions)
2. Position the suspension bar on the required place and using a spirit level, balance the bar
3. Mark with a pencil the points where holes will be drilled
4. Remove the bar and using a Ø 10 mm drill, drill the necessary holes
5. Insert dowels into the hole and consequently secure it using the attached bolts
6. Suspend the boiler on the bar
7. Install piping for the exhaustion of burnt gases and the air supply. Fill the space between the piping and the hole in the wall with fireproof material (remember to keep it dismantlable for smoke collection).

In the case of installation on a wall with lower load-bearing capacity, it is recommended to consult the installation with a service technician. Around the boiler, due to service inspection or potential service intervention, leave a manipulation area so to be able to easily work with your hands around the boiler using standard hand held tools.

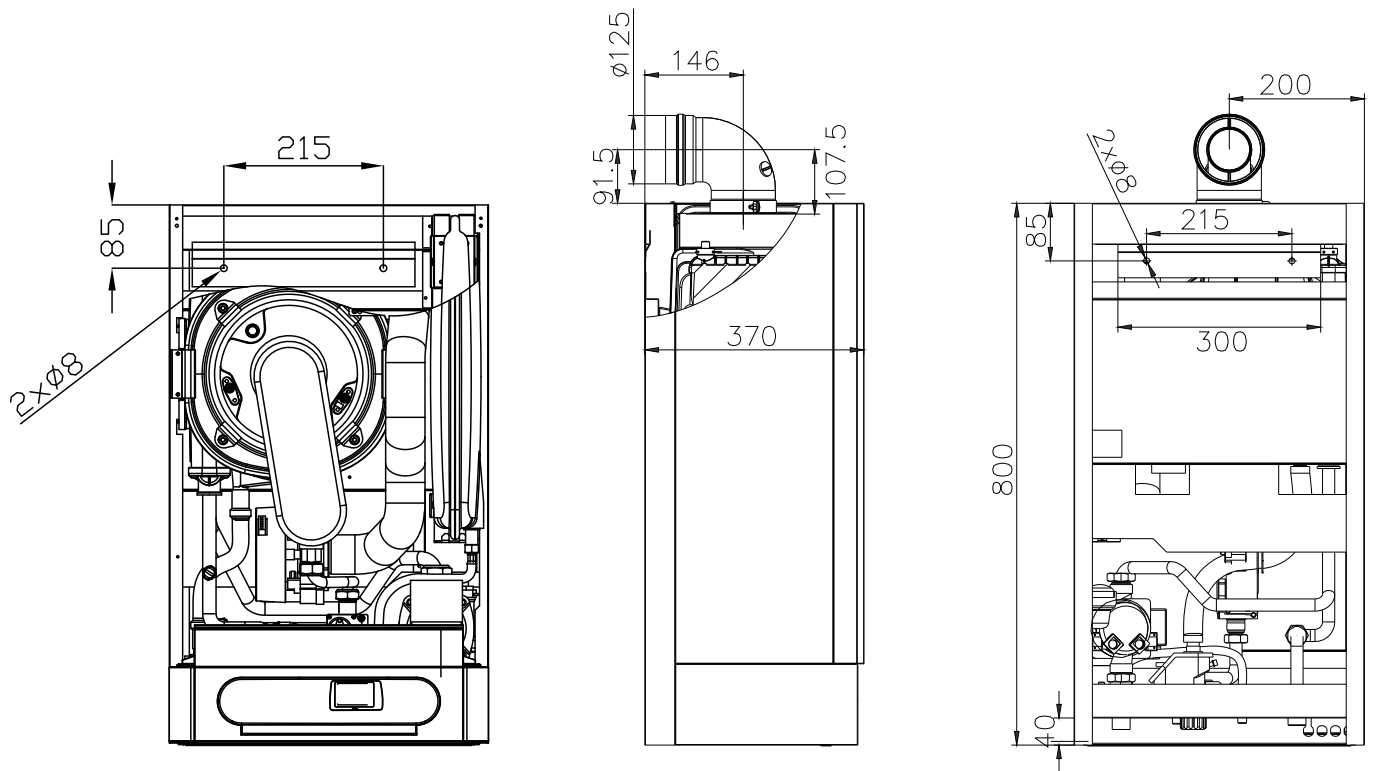

3.5 Connecting the boiler to the hot-water system

The boilers must be connected to the heating system in such a manner that the power fittings do not stress the connecting outlets of the boiler and there is no aeration.

As it concerns a heat-water flow boiler fitted with its own pump, it is necessary to resolve the connection to the heating system in relation to the calculations of the hydraulic relations of the whole system. Due to the optimal use of the condensing regime of the boiler, it is recommended to design heating systems for low temperatures ($\Delta t = 50/30\text{ }^{\circ}\text{C}$). The minimum overpressure of the system is 0.8 bar. We recommend using the pressure of the heating water in the system within the range 1.0 – 1.5 bar.

3.5.1 Dimensions and connection

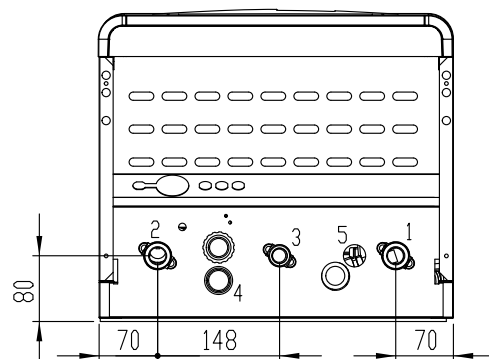
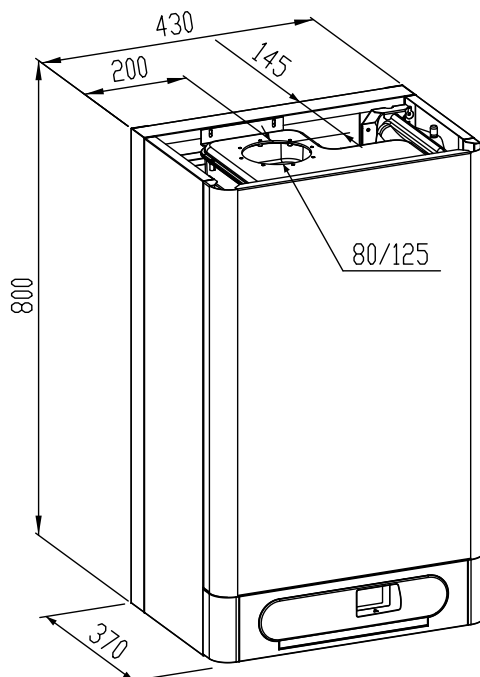

BOILER CONNECTION	BOILER MODEL		
	UNIT	TYPE OF THREAD	45 KD.A
Input for returned water	G 1"	outside	1
Output for heating water	G 1"	outside	2
Input for gas	G 3/4"	outside	3
Condensate outlet			4
Output safety valve			5

3.5.2 Graphs of the connecting overpressures of heating water (on the output for heating water)

Notice: The curves of the connecting over-pressures of heating water are designed for **Wilo RS 15/7,5** pumps for the outside regulation stage.

! Due to the delivered output of the boiler and the resistance properties of the exchanger, we do not recommend decreasing the output of the pump.

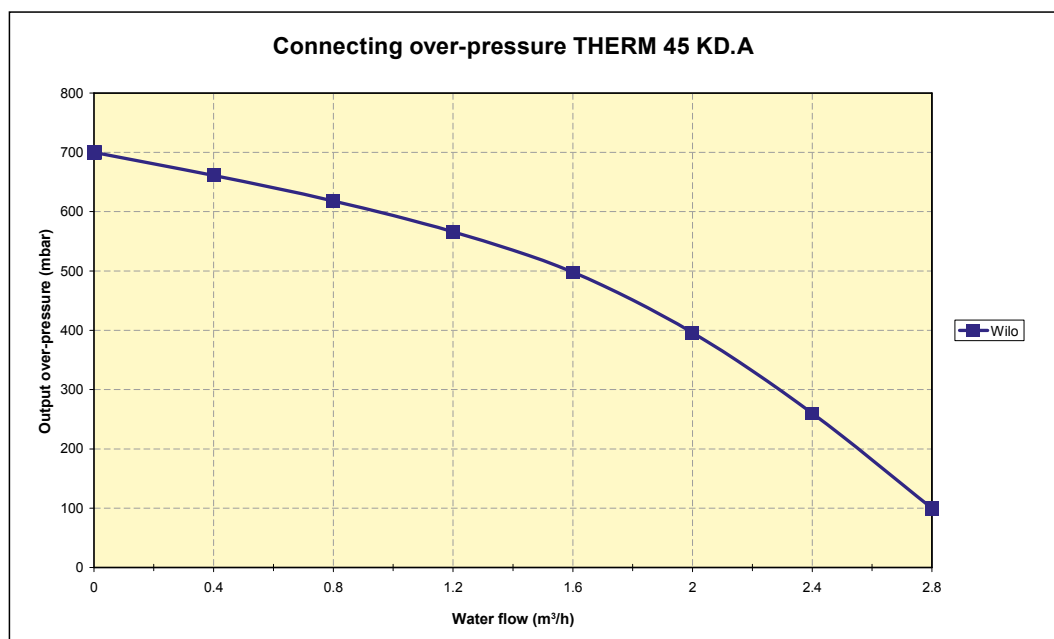

! The piping system must be located to prevent the origination of air bubbles with the aim to make de-aeration easy. The de-aerating elements should be mounted on all the highest located parts of the heating system and also on all heating bodies.

Before testing and commissioning, according to ČSN 06 0310, the assembly must include perfect flushing of the heating system up to fully clean status. To prevent the penetration of dirt into the boiler system, the entrance of the return water from the heating system into the boiler must be fitted with a suitable filter and sludge separator. It is necessary to clean and inspect the filter and sludge separator in regular intervals.

The heating system must be implemented in accordance with ČSN 06 0830 – Heating systems in buildings – Security equipment and with ČSN 06 0310 – Heating systems in buildings – Design and assembly.

! The producer requires:

- mount into the slides of the pump filter and de-sludge equipment (e.g. Spirovent Kal)
- mount a bypass valve in heating systems with thermostatic valves
- install the valve in the lowest point of the system near the boiler for filling and discharging the heat-carrying medium from the heating system and for sludge separation
- mount de-aerating equipment on the output of the boiler and on the top point of the heating system

💡 The producer recommends:

- to fill the system with soft water according to ČSN 07 7401
- to separate the boiler on the input and output with a stop valve (see ČSN 06 0830), so in the case of inspection, repair of the boiler or cleaning of the filter, it is not necessary to discharge the whole system
- to remove the control levers from the valves during operation and secure against manipulation

3.5.3 Expansion tank

THERM 45 KD.A serie boilers are not equipped with an expansion tank of the heating system. The heating system is necessary to provide with an external expansion tank with the volume specified in the heating project.

3.5.4 Using anti-freeze mixtures

It is not recommended to fill heating systems with anti-freeze mixtures due to their properties. This generally concerns the decrease of the delivery of heat, large volume expansion, ageing and damage to the rubber parts of the boiler.

3.5.5 Safety valve

In the lower part of the boiler is a safety valve. When operating the boiler, under certain circumstances, there can be penetration of water or escape of steam from the safety valve. Due to this reason it is recommended to install on the output of the safety valve suitable leakage which will terminate into the waste system.

! Under no circumstances is it permitted to manipulate with the safety valve during operation of the boiler!

3.6 Connection of the boiler to the gas distribution

The boiler must only be connected to gas by an authorized firm according to ČUBP Regulation and ČBU 21/1979 Coll. (as amended by Regulation 554/1990 Coll.) by employees with the qualification according to FMPE Regulation 175/1975 Coll. (as amended by FMPE Regulation 18/1986 Coll.) and according to the approved documentation for gas installation. It is not necessary to install the gas regulator before the boiler. It is contained in the compounded gas fitting which is part of the boiler. In the boiler input there must be a ball valve with the respective attestation for gas. The gas closure must be freely accessible. The boiler is designated for operation with natural gas with calorific capacity 9 – 10,5 kWh/m³ and a nominal pressure in the distribution network of 20 mbar.

! After the termination of the assembly of the gas lines to the boiler, it is necessary to consistently check the tightness of all joints!

3.7 Filling and discharging of the heating system

When filling the heating system the boiler must be disconnected from the electricity network by disconnecting the fork from the socket. Filling must be done slowly so that the air can flow through the respective de-aerating valves. The water for the first filling and for additional filling must be according to ČSN 07 7401 clear, without colour, without suspended substances, oil and chemically aggressive ingredients, must not be acid (pH must not be lower than 7), with minimum carbonate hardness (max. 3.5 mval/l). For modification of the hardness, it is necessary to use preparations approved by producer.

3.7.1 Procedure for filling the heating system:

1. check and adjust the pressure in the expansion vessel according to the stated static pressure in the system.
2. open the charging valve of the heating system and on the manometer monitor the increasing pressure in the heating system
3. after filling the heating system, the pressure should be within the range 1.0 – 1.5 bar
4. carefully de-aerate all radiators (during the circulation of water no air bubbles should be heard)
5. check the water pressure in the system again – after de-aeration it will probably be to pressurize the heating system
6. Check that the de-aerating valves on the heating bodies are closed
7. Before activating the boiler, it must be de-aerated

If these requirements are not fulfilled, the warranty for damaged components will not be applicable.

3.7.2 Additional filling of water into the heating system

The additional filling of water into the system is described in the Chapter "Maintenance and Service" and in the „User Manual“part.

3.7.3 Discharging of water from the heating system

The full discharging of water from the whole heating system must be resolved by the system discharging valve located in the lowest point of the heating system.

3.8 Condensate outlet

The boiler is fitted with an odour closure (siphon), which must be flooded before running the boiler with about 100 ml of water. Firstly, it is necessary to connect neutralizing equipment to the outlet for the condensate and then to discharge the condensate to the sewerage piping. The discharging of the condensate into the sewerage piping is governed by national or regional (local) regulations.

The collection piping must have a minimum declination of 5° from the boiler into the sewerage piping and must not be blocked (in the case of blocking the collection of the condensate, there is resonance of the combustion chamber of the boiler chamber).

Condensate analysis

Pointer	Unit of measure	45 kW
pH	-	3.0
Nitrites	mg.l ⁻¹	0.06
Copper (Cu)	mg.l ⁻¹	0.2
Lead (Pb)	mg.l ⁻¹	0.65
Cadmium (Cd)	mg.l ⁻¹	1.25
Zinc (Zn)	mg.l ⁻¹	2.1

3.9 Design of gas exhaust

The exhaust for burnt gases of these types of boilers must be designed by means of the certificate smoke collection system delivered by the producer. From the viewpoint of checking the route for burnt gases, it is necessary to ensure that the exhaust for burnt gases has a suitable revision hole. The exhaust for burnt gases and any connection to the chimney must be in accordance with ČSN 734201. The actual performance of the exhaust for burnt gases must be designed and prepared in the project for the connection of the boiler while respecting the standard rules for collection of condensate. The horizontal piping must be installed with the slope 2° from the terminal unit in the direction from the boiler to prevent any escape of the condensate (and possible freezing) from the terminal unit of the exhaust into the surroundings.

For THERM 45 KD.A condensing boilers, the following methods for the collection of burnt gases are approved:

- coaxial smoke collection tube with a diameter of 80/125 mm
- separate smoke collection tube with a diameter of 2 x 80 mm

Permitted maximum lengths of smoke collection tube:

Diameter of the smoke collection tube	Max. length - horizontally	Max. length - vertically
80/125 mm	5 (10, 15)* m	5 (10, 15)* m
2 x 80 mm	2 x 5 m	2 x 5 m

* If extending the exhaust to 10 m, the boiler output must be restricted to a maximum output of 2 kW; in the case of extending to 15 m, then by a further 2 kW

Minimum length of smoke collection is 1 m. The first knee in the case of horizontal smoke collection is included into the maximum length of smoke collection. The second and subsequent further knees shorten the maximum length by:

- 0,5 m - knee 45°
- 0,75 m - knee 90°



The maximum total pressure loss of gas collection is 95 Pa.

Example of gas collection

Coaxial system (60/100, 80/125)

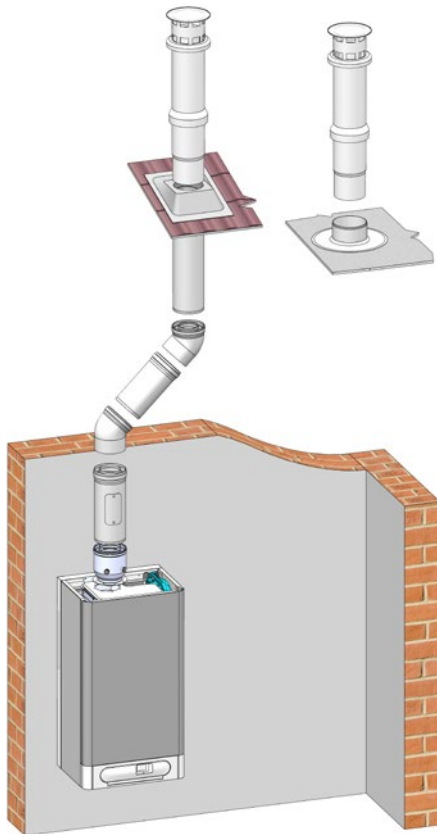

Divided system (2 x 80)

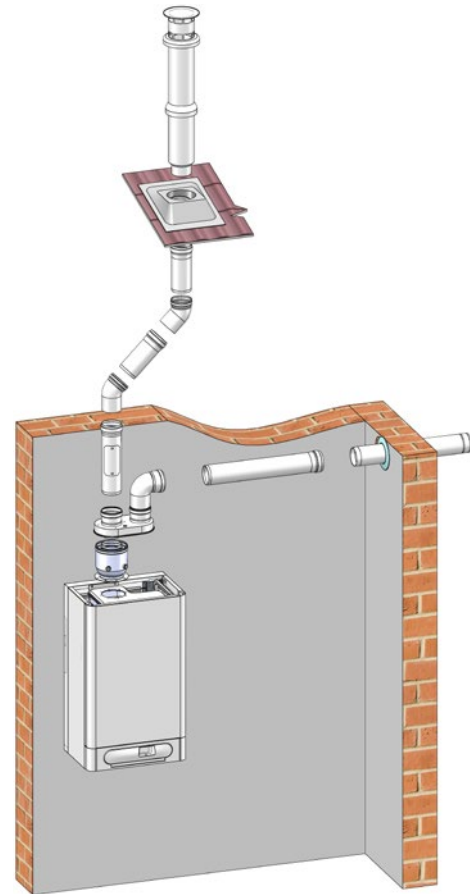

3.10 Connection of the boiler to the storage tank

THERM 45 KD.A boilers (after expansion by a three-way valve) can efficiently and reliably resolve heating water together with the heating system. A detailed description of the water heating is in Chapter 2.3.6.



The output of the boiler to which the water storage tank is connected, should correspond to the nominal output of the heating insert or heat exchange of the surface in the storage tank. In the case of over-sizing of the boiler related to the heating insert, there is overheating of heating water in the stated circuit and consequent cycling of the boiler. This phenomenon closely relates to the increased consumption of gas.

3.11 Connection of the boiler to the electricity network

Boilers are fitted with a three-conductor supply cord with an unseparated fork according to ČSN 34 0350 ed.2: 2009. The connection to the network is performed pursuant to the requirement of Article 25.1 ČSN EN 60335-1 ed.3: 2012. into the network socket located at the boiler. The socket must fulfil the following requirements: must fulfil protection against the hazardous contact of non-live parts in TN networks TN (formerly called zeroing) or in TT network (formerly called grounding) and the connection must be made according to **ČSN 33 2180** so that the protective pin is on the top and the middle or zero conductor is connected (front view) to the right hollows. The network voltage must be $230\text{ V} \pm 10\%$.



The installation of the socket, connection of the room thermostat and the service of the electrical part of the boiler must only be carried out by person with the respective professional electro-technical qualification according to the Regulation No. 50/1978 Coll..

3.11.1 Connection of the room thermostat

To control the boiler by the room thermostat, only such a thermostat that has voltage-free contact can be used, i.e. no other voltage is supplied into the boiler.

It is necessary to connect the room thermostat to the boiler by a two-core conductor. The recommended cross-section for connection of the room thermostat for a copper conductor (wire) is from 0,5 to 1,0 mm².

The terminal board for connection of the room thermostat is located inside the control panel of the boiler (see the electric diagram of the connection of the boiler). It is equipped in production with an interconnecting unit. The interconnecting unit is removed only when connecting the room thermostat! The terminal board is accessible after removing the outside cover, tilting and consequent dismantling of the rear part of the control panel.

3.11.2 Connection of a room regulator with OpenTherm+ communication

The intelligent room regulator is connected similarly as the connection of the traditional spatial thermostat. The regulator is connected to the same terminal. It is not possible to connect two types of regulators at the same time!

Technical recommendation during the connection of the regulator with OpenTherm+ communication with the boiler

The connecting cable supplies the regulator for the transfer of the signal of the mutual communication by the protocol OpenTherm+ between the automatic system of the boiler and the regulator.

- Number of conductors in the line : 2
- Maximum length of the line : 50 metres
- Maximum resistance of the line : 2 x 5 Ohm
- Polarity : non polarized connection (conductors can be exchanged)



To prevent the resolution of the communication, it is necessary to use a pair or a shielded pair of conductors! The connecting cable must not run in parallel or cross the power lines! The cable shielding must be mutually interconnected and grounded to the fasten grounding to the automatic boiler system (the shielding must not be grounded to the body in several places!). For example, a SYKFY cable is recommended.

3.12 Variants for the installation of the boiler

Construction:

C₁₃ - axial horizontal variant with termination to the peripheral wall. The piping can be double, the termination is either concentric or closely located (location inside the square with the side 50 cm), so it is affected by the same atmospheric conditions.

C₃₃ - Coaxial vertical variant with termination on the roof. The piping can be double, the termination is either concentric or closely located (location inside the square with the side 50 cm and the distance between the areas of two holes must be less than 50 cm) so it is affected by the same atmospheric conditions.

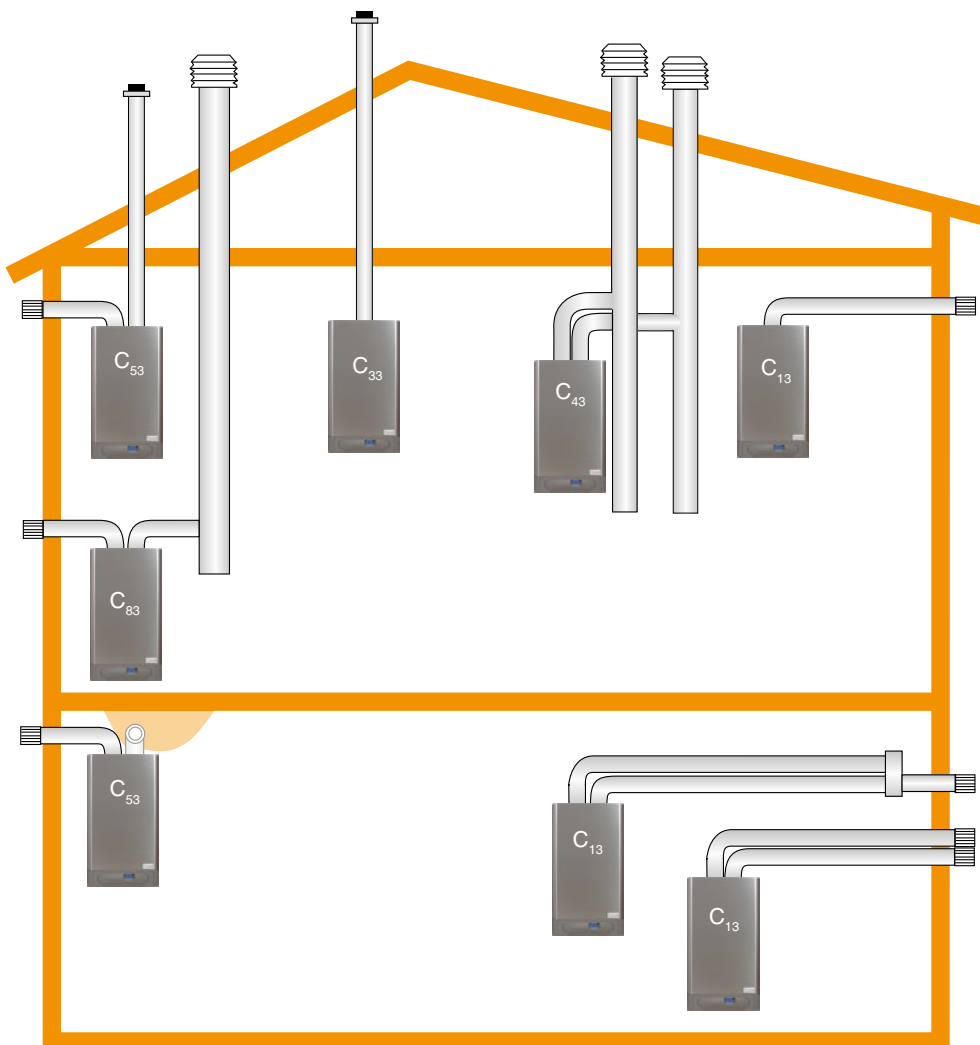

C₄₃ - Separated connection to two pipes of the common shaft. The termination of shafts is either concentric or closely located (location inside the square with the side 50 cm), so that it is affected by the same atmospheric conditions.

C₅₃ - Separated pipe with termination to the peripheral wall or on the roof, in different pressure zones, but under no circumstances to two opposite peripheral walls.

C₈₃ - Separated connection with the collection of burnt gases from a separate or common chimney. Supply for the combustion gas is from the peripheral wall.

4. ADDITIONAL INFORMATION FOR SERVICE

4.1 Gas fitting SIEMENS VGU 86 – setting

SIEMENS VGU 86 is gas fitting with the proportional regulation air / gas. It is fitted with two solenoid valves for blocking the passing gas during any inactivity of the boiler. The regulating system works depending on the feedback signal of the gas pressure from the mixer. In addition to closable measuring adapters for the input, output and medium gas pressure, there are elements for setting the correct ratio of air – gas within the whole range of the regulation of the output of the boiler. Setting the parameters of the gas fitting, i.e. regulation starting and setting the ratio of the mixture is performed by a service technician during activation of the boiler. This action must be done using the TORX T15 key according to the emission values of burnt gases measured by the service analyzer!

Electrical connection of the connector for solenoid coils

Gas fitting contains two EV1 solenoid valves (gas input solenoid) and EV2 (regulation system solenoid). Coils are connected in the connector in parallel (i.e. they are connected at the same time). The supply voltage of the coils is 230 V AC (alternate).

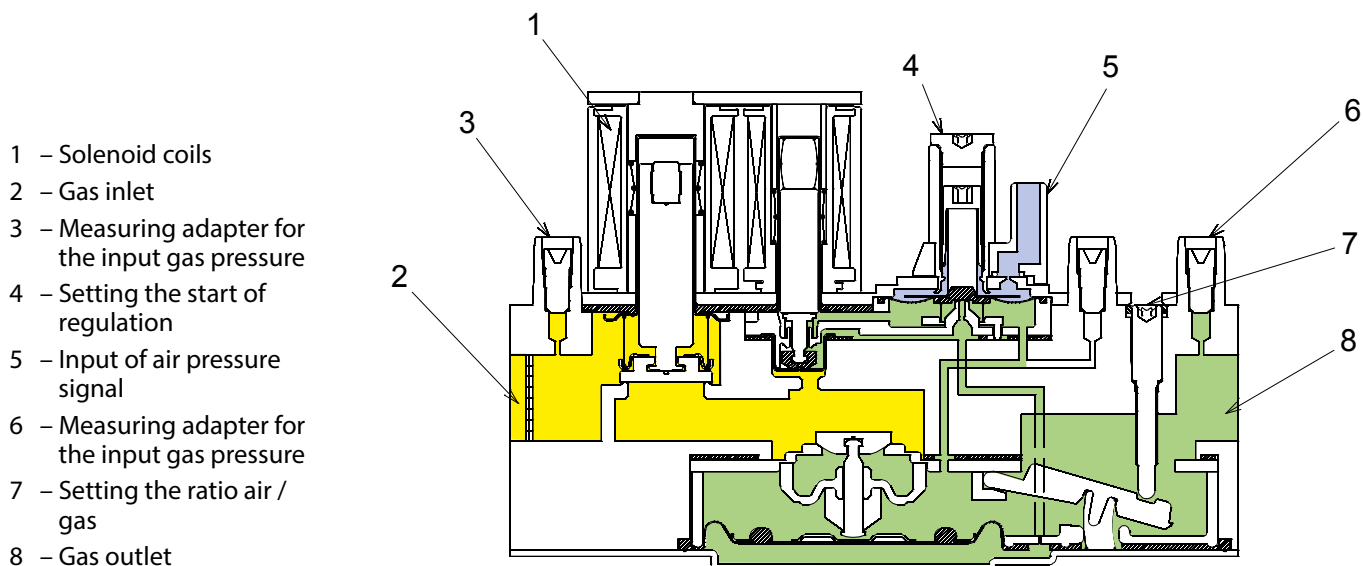
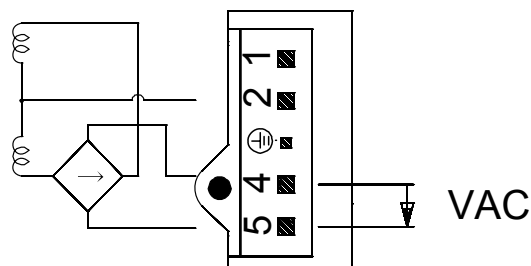

The gas fitting is set exclusively by an employee of the authorized service organisation!

4.2 Electrical connection diagram

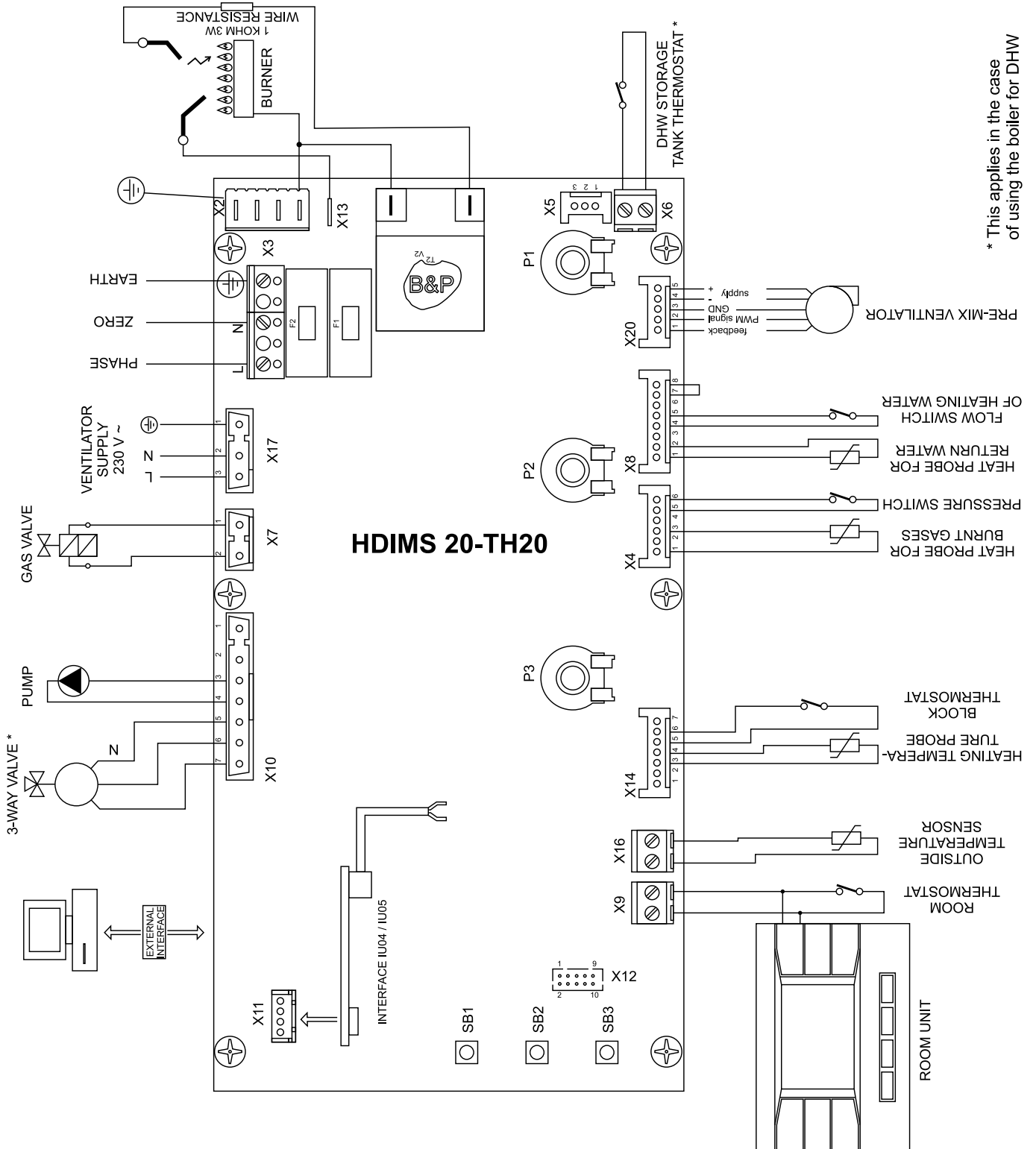

* This applies in the case of using the boiler for DHW

5. RECORD OF WARRANTY AND POST-WARRANTY REPAIRS AND ANNUAL CONTROLS

Performed action	Contractual organisation	Signature of client	Date of record

Notification of package and product disposal after termination of its service life:
 All materials used are fully harmonized with the requirements stated in Section 10 of Act No. 185/2001 Coll. and section 6 of Act No. 477/2001 Coll..
 The packaging of the product is collected by collecting units for paper waste, wrapping foil into the collection units for plastics.
 Parts of the boiler from steel, copper and copper alloys are collected into the sorted metal collection units.
 The thermal insulation of the combustion chamber is harmless to health and is disposed of in common communal wastes.
 For storage it is necessary to ensure standard storage conditions (non-aggressive and dust-free environment, range of temperatures 5 to 50 °C, air moisture up to 75 %, with the prevention of biological influences, shocks and vibrations).
To comply with the ecological parameters of the product, it is necessary to ensure inspection and maintenance each year. This inspection includes complete cleaning of the boiler and adjustment of the burner.

6. CERTIFICATE OF QUALITY AND COMPLETENESS OF THE PRODUCT

THERM gas condensing boilers

Indication of model: **THERM 45 KD.A**

Serial number:

The product delivered with this certificate corresponds to valid technical standards and technical conditions. The product was produced according to the respective drawing documentation, within the required quality and is approved by the Technical Testing Institute in Piešťany, Slovak Republic, EC notified body, identification number 202.

THERM 45 KD.A

- Certificate of testing of the model according to the EC Directive for consumer appliances for gas fuel 2009/142/EEC, No. E-30-00808-13
- Certificate of testing for the model according to the EC Directive for efficiency 92/42/EEC No. E-30-00809-13

THERM 45 KD.A boilers have been awarded the registered trademark "Ecologically friendly product" No. 65 - 01. They are classed as products with a minimum environmental effect.

Technical inspection

date:

seal and signature:

The logo for Thermona, featuring the word "Thermona" in a bold, blue, serif font. A blue curved line arches over the letters "ermona". A registered trademark symbol (®) is located at the top right of the arch.

everything we do warms

THERMONA, spol. s r. o.

Stará osada 258, 664 84 Zastávka u Brna

Czech Republic

Tel.: +420 544 500 511, fax: +420 544 500 506

thermona@thermona.cz

www.thermona.cz



© THERMONA 2015

Thermona[®]

THERMONA, spol. s r.o., Stará osada 258, 664 84 Zastávka u Brna,
☎ 544 500 511 • FAX 544 500 506 • ✉ thermona@thermona.cz • www.thermona.cz